

**TEAC<sup>®</sup>**



**SERVICE MANUAL**

---

# **A-70/A-50**

**DC Integrated Stereo Amplifier**

---

# 1 SPECIFICATIONS

**Type** DC Integrated Stereo Amplifier

**Rated Output Power**  
50 W + 50 W (A-50: 30 W + 30 W),  
Both Channels, 8 ohms 30 Hz – 20 kHz,  
0.05% (A-50: 0.06%) T.H.D.

**Total Harmonic Distortion**  
1 kHz, at Rated Output Power, 0.006%  
(A-50: 0.01%)

**Output Bandwidth**  
IHF, -3 dB, 10 Hz – 50 kHz

**Frequency Response**  
Tuner/Aux/Tape 1, 2 to SP out  
10 Hz – 55 kHz +0, -2 dB  
Phono to Rec Out, 20 Hz – 20 kHz ± 0.5 dB  
(RIAA)

**Input Sensitivity**  
Phono MC 200  $\mu$ V/100 ohms (A-70 only)  
Phono MM 2.5 mV/47 k ohms  
Tuner/Aux/Tape 1, 2 150 mV/33 k ohms

**Rated Output Voltage/Impedance**  
Tape Rec 1, 2 150 mV/33 k ohms

**Signal-to-Noise Ratio (IHF A Network)**  
Phono MC 66 dB (A-70 only)  
Phono MM 82 dB  
Tuner/Aux/Tape 1, 2 96 dB

**Damping Factor** 30

**Tone Control**

Bass  $\pm$ 10 dB, 100 Hz  
Treble  $\pm$ 10dB, 10 kHz  
High Filter 10 kHz, 6 dB/oct  
Subsonic Filter 15 Hz, 6 dB/oct  
Muting 20 dB

**Power Requirements**

100/120/220/240 V AC 50/60 Hz,  
92 W (A-50: 52 W) (General Export Model)  
120 V AC 60 Hz, 98 W (A-50: 60 W)  
(U.S.A. Model)  
120 V AC 60 Hz, 1.7 A (A-50: 1.4 A)  
(Canada Model)  
220 V AC 50 Hz, 270 W (A-50: 160 W)  
(Europe Model)  
240 V AC 50 Hz, 350 W (A-50: 190 W)  
(U.K./Aus. Model)

**Dimensions (W x H x D)**

432 x 72 x 296 mm (17" x 2-13/16" x 11-5/8")

**Weight**

7 kg (15-7/16 lbs) net

- Improvements may result in specification or feature changes without notice.
- Photos may differ slightly from production models.

**NOTES**

1. In this manual, 0 dB is referenced to 1 V.
2.  $\Delta$  Parts marked with this sign are safety critical components. They must always be replaced with identical components – refer to the appropriate parts list and ensure exact replacements.
3. PC boards shown are viewed from foil side.

## 2 VOLTAGE CONVERSION (FOR GENERAL EXPORT MODELS)

BE SURE TO REMOVE THE POWER CORD FROM THE AC OUTLET BEFORE REMOVING THE METAL COVER AND REPOSITIONING THE VOLTAGE CONVERSION PLUG.

1. Remove the metal housing covering the top and sides of the unit by removing the screws from each side of the metal cover.
2. Locate the voltage selector plug on the left side of the unit.
3. Remove the plug by pulling it out, then re-insert it so that the arrow on the plug is aligned with the white line indicating the proper voltage.
4. Replace the cover.

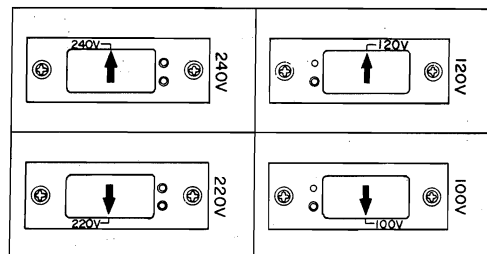

Fig. 2-1

### 3 PARTS AND ADJUSTMENTS LOCATION

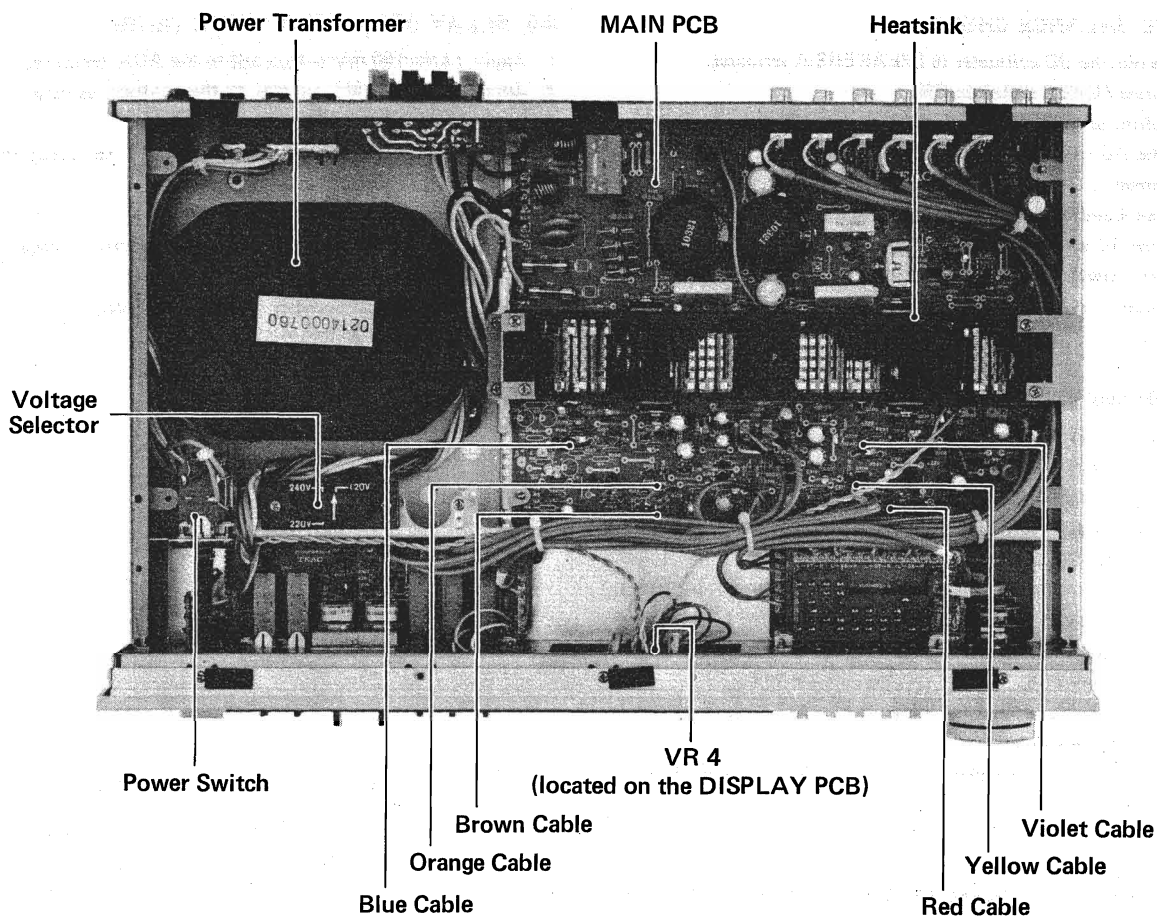

Fig. 3-1

## 4 ADJUSTMENTS

### 4-1 INITIAL SETTINGS

Without applying AC power, set the controls as shown below.

Control	Position or setting
SPEAKERS	A
BASS	0
TREBLE	0
Input	AUX
TAPE COPY	OUT
MONITOR	SOURCE
MUTING	OUT

Control	Position or setting
FILTER	OUT
LOUDNESS	OUT
MODE	STEREO
BALANCE	Center
VOLUME	min
CARTRIDGE	MM (A-70 only)

## 4-2 DC BALANCE CHECK

1. Connect the DC voltmeter to SPEAKERS A terminal.
2. Depress POWER switch to ON.
3. Confirm the DC voltmeter indication within  $0\text{ V} \pm 50\text{ mV}$ .
4. If the DC voltmeter indicates over  $+50\text{ mV}$ , cut the orange cable between 3 and 3 terminals (for L-ch) or the yellow cable between 4 and 4 terminals (for R-ch) on the MAIN PCB.
5. If the DC voltmeter indicates less than  $-50\text{ mV}$ , cut the brown cable between 1 and 1 terminals (for L-ch) or the red cable between 2 and 2 terminals (for R-ch) on the MAIN PCB.

## 4-3 IDLING CURRENT CHECK

1. Connect the DC voltmeter between TP-3 (L-ch)/TP-5 (R-ch) and TP-1 (L-ch)/TP-6 (R-ch) for the A-70 or TP-2 (L-ch)/TP-5 (R-ch) and TP-1 (L-ch)/TP-4 (R-ch) for the A-50.
2. Confirm the DC voltmeter indication within  $5\text{ mV}$  when POWER is ON after 10 seconds.
3. If the DC voltmeter indicates over  $5\text{ mV}$  (A-70) or  $7\text{ mV}$  (A-50), cut the blue cable between 6 and 6 terminals for LEFT channel or the violet cable between 7 and 7 terminals for RIGHT channel on the MAIN PCB.
4. After the above procedures, allow 10 minutes for the amplifier to warm up completely.
5. Confirm the DC voltmeter indication which should be within  $2\text{ to }25\text{ mV}$ .

## 4-4 PEAK LEVEL DISPLAY ADJUSTMENT

1. Connect the AC voltmeter to SPEAKERS A terminal.
2. Set the VOLUME control to maximum.
3. Apply a  $1\text{ kHz}$  input signal to provide an output voltage of  $25\text{ V}$  (A-70) or  $20\text{ V}$  (A-50) to the AUX terminal.
4. Adjust VR4 on the DISPLAY PCB so that the  $50\text{ W}$  (A-70) or  $30\text{ W}$  (A-50) LED in the PEAK LEVEL DISPLAY lights up with the full intensity but the  $100\text{ W}$  (A-70) or  $60\text{ W}$  (A-50) LED do not light.

## 4-5 RELAY OPERATION CHECK (A-70)

1. Apply  $1\text{ kHz}/150\text{ mV}$  ( $-16.5\text{ dB}$ ) to the AUX terminal.
2. Adjust the VOLUME control so that output voltage is  $1\text{ V}$  at the SPEAKER terminal.
3. Apply a  $+2.5\text{ V}$  or  $-2.5\text{ V}$  DC to the TP-7 to cause the relay RY1 to break immediately.
4. Remove the DC signal from the TP-7.
5. Adjust the VOLUME control so that output voltage is  $0.5\text{ V}$  at the SPEAKER terminal.
6. Shortcircuit the SPEAKER terminal between + and - so that the relay RY1 break immediately.

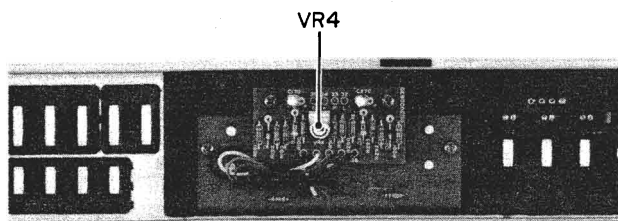

Fig. 4-1

**5 BLOCK DIAGRAM**

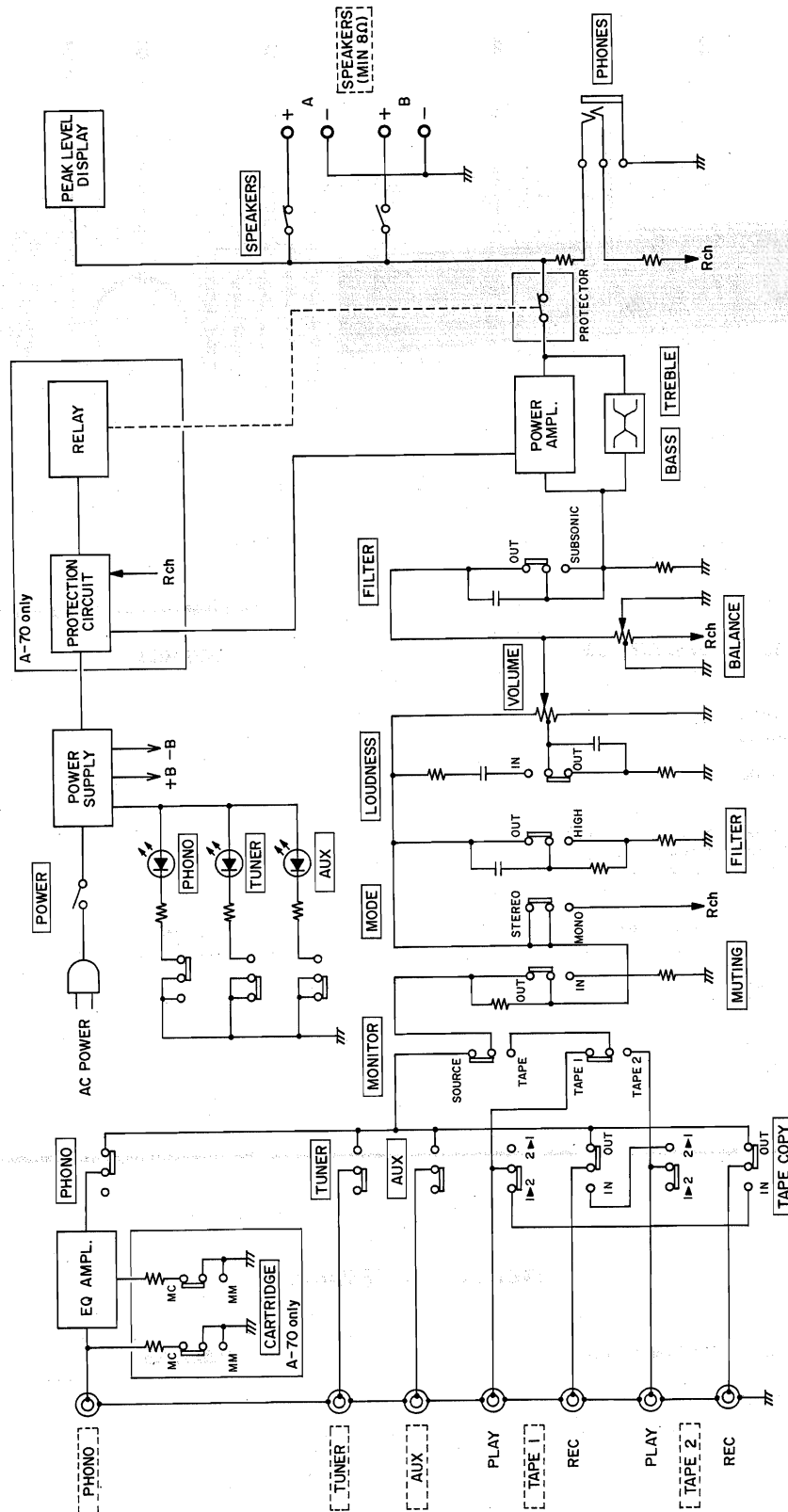
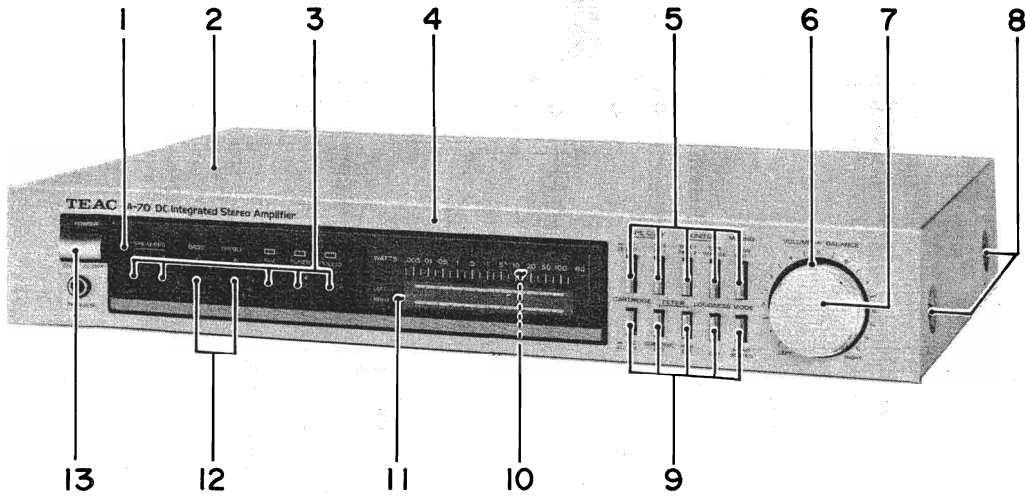

Fig. 5-1

# A-70/A-50

## 6 PARTS LOCATION AND PARTS LIST

### PARTS LOCATION-1



Parts marked with \*require longer deliver time.

REF. NO.	PARTS NO.	DESCRIPTION	REMARKS
1 - 1		Sheet, Escutcheon	Part of 1 - 4
1 - 2	*5760108100	Cover, Top	
1 - 3	*5760094400	Button, Push; C	
1 - 4	*5760219300	Panel Assy, Front	A-70
	*5760219200	Panel Assy, Front	A-50
1 - 5	*5760094100	Button, Push; A	
1 - 6	*5760108000	Knob, BALANCE	
1 - 7	*5760107900	Knob, VOLUME	
1 - 8	*5783114006	Screw, M4x6 (BLK)	
1 - 9	*5760094300	Button, Push; B	
1 - 10		Plate, Scale	A-70 Part of 1 - 4
		Plate, Scale	A-50 Part of 1 - 4
1 - 11		Plate, Meter	Part of 1 - 4
1 - 12	*5760107800	Knob, Tone	
1 - 13	*5760094000	Button, POWER	

### INCLUDED ACCESSORIES

REF. NO.	PARTS NO.	DESCRIPTION	REMARKS
	5700021500	Owner's Manual	

## PARTS LOCATION-2

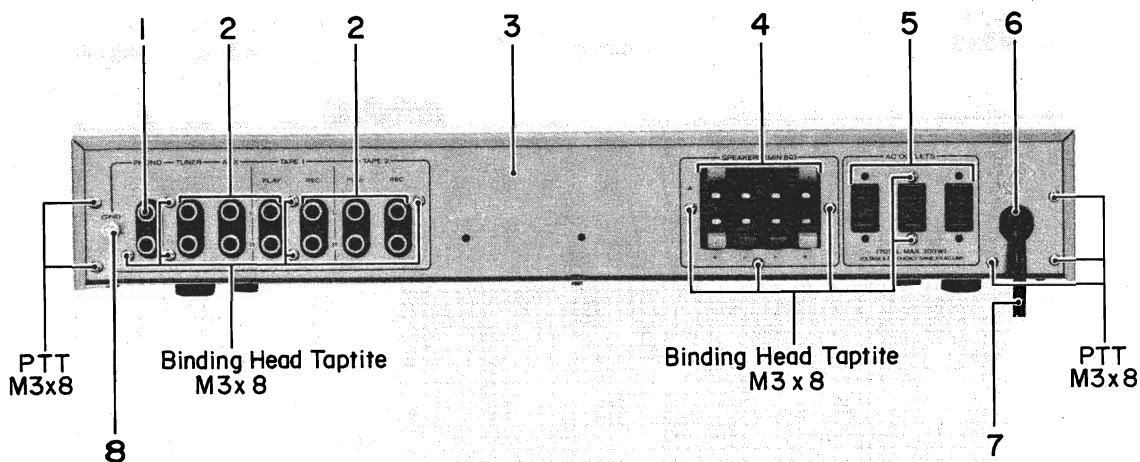

Parts marked with \*require longer delivery time.

REF. NO.	PARTS NO.	DESCRIPTION	REMARKS
2 - 1	*5760142100	Jack, Pin; 2P	
2 - 2	*5330505200	Jack, Pin; 6P	
2 - 3	*5760103500	Panel, Rear; A [US, C, GE]	
	*5760107300	Panel, Rear; B [E, UK, A]	
2 - 4	*5760102700	Terminal, Push; 8P	
2 - 5	△*5760101000	Socket, AC; 3P [US, GE]	
	△*5760098600	Socket, AC; 3P [C]	
2 - 6	*5800136400	Strain Relief, Cord; 4P-4 [US, C, GE]	
	*5800136500	Strain Relief, Cord; 4K-4 [E, UK, A]	
2 - 7	△*5760098100	Cord, AC Power [US, C, GE]	
	△*5760098200	Cord, AC Power [E]	
	△*5760098300	Cord, AC Power [UK]	
	△*5760098400	Cord, AC Power [A]	
2 - 8	*5760081300	Nut, GND	
	*5785213000	Washer, Fiber (BLK) $\phi 3 \times \phi 6 \times t0.5$	

## PARTS LOCATION-3

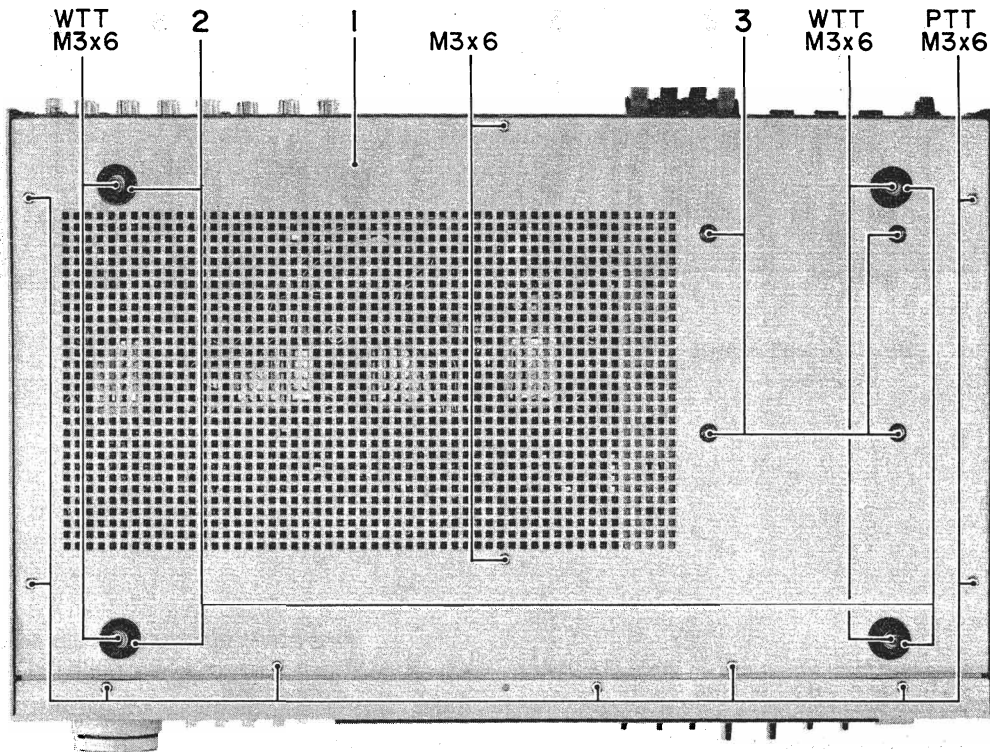

Parts marked with \*require longer delivery time.

REF. NO.	PARTS NO.	DESCRIPTION	REMARKS
3 - 1	*5760108300	Cover, Bottom	
3 - 2	*5760095000	Foot	
3 - 3	*5783114006	Screw, M4x6 (BLK)	



**PARTS LOCATION-4**

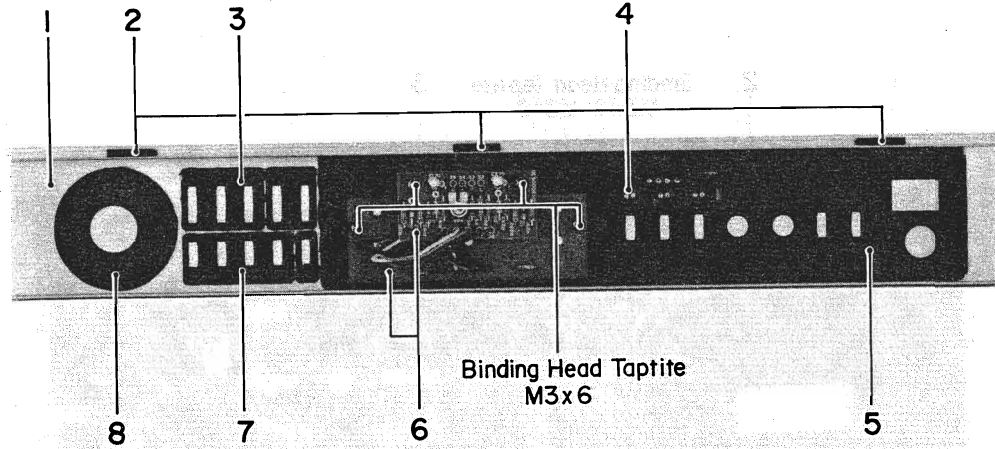

Parts marked with \*require longer delivery time.

REF. NO.	PARTS NO.	DESCRIPTION	REMARKS
4 - 1	*5760219300	Panel Assy, Front	A-70
	*5760219200	Panel Assy, Front	A-50
4 - 2	*5760095500	Cushion, A	
4 - 3		Guide, Button; B	Part of 4 - 1
4 - 4	*5760109600	PCB, LED Assy	
4 - 5		Escutcheon, Panel	Part of 4 - 1
4 - 6	*5760109900	PCB Assy, DISPLAY [All except C]	
	*5760109910	PCB Assy, DISPLAY [C]	
4 - 7		Guide, Button; A	Part of 4 - 1
4 - 8		Cover, Knob	Part of 4 - 1

**PARTS LOCATION-5**

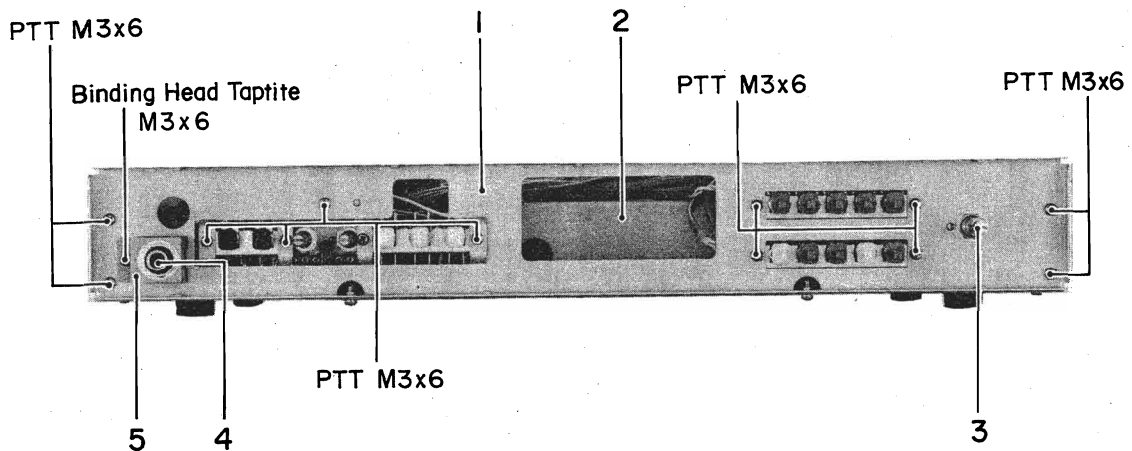

Parts marked with \*require longer delivery time.

REF. NO.	PARTS NO.	DESCRIPTION	REMARKS
5 - 1	*5760101300	Flame, Front	
5 - 2	*5760101400	Flame, Front	
5 - 3	5760121200	Var. Res., 250kΩ(B)x2/500kΩ(W)	
5 - 4	*5760141300	Jack, Headphone	
5 - 5	*5760108400	Bracket, Jack	

**PARTS LOCATION-6**

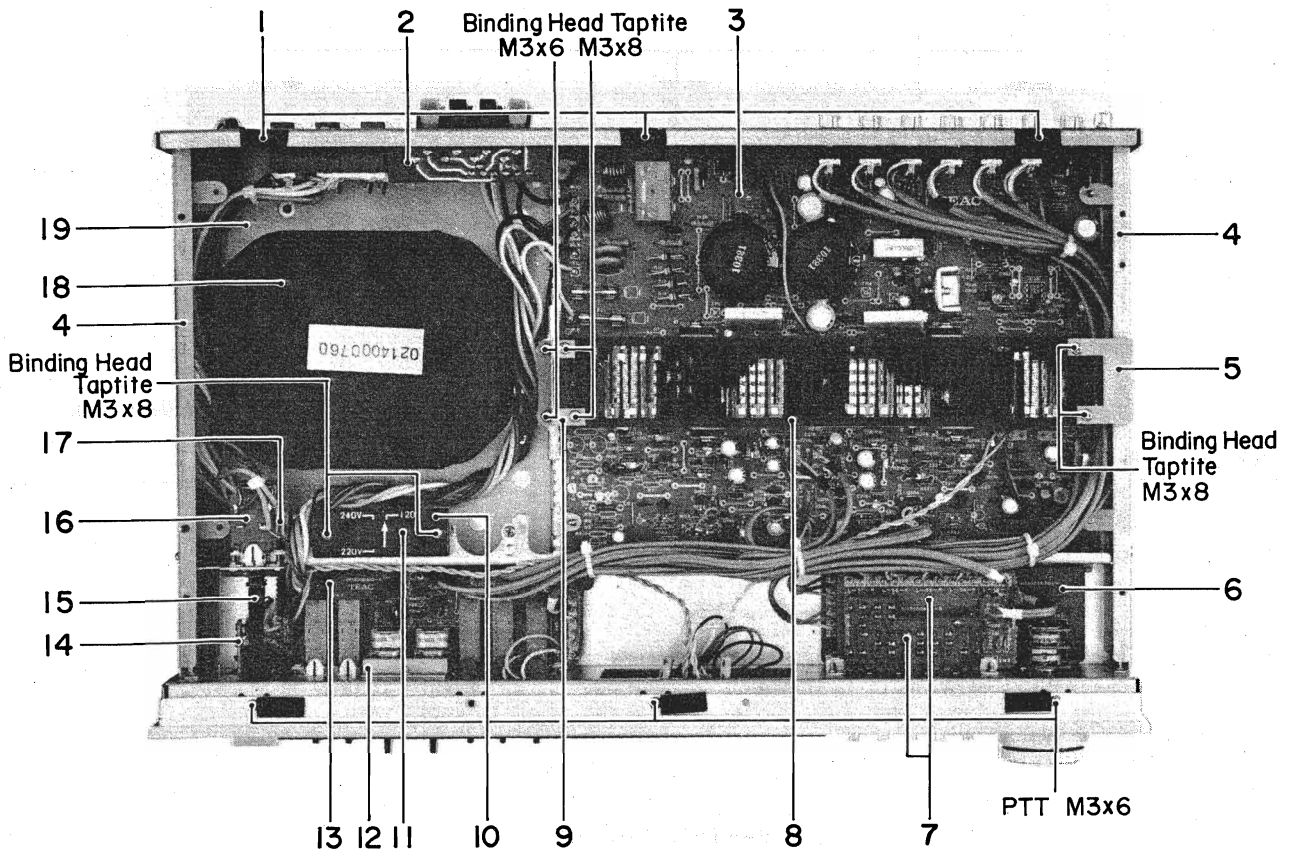

Parts marked with \*require longer delivery time.

REF. NO.	PARTS NO.	DESCRIPTION	REMARKS
6 - 1	*5760095600	Cushion, B	
6 - 2	*5760109400	PCB Assy, SP TERMINAL [All except C]	
	*5760109410	PCB Assy, SP TERMINAL [C]	
6 - 3	*5760109200	PCB Assy, MAIN [US]	A-70
	*5760109210	PCB Assy, MAIN [C]	A-70
	*5760109220	PCB Assy, MAIN [All except US, C]	A-70
	*5760110400	PCB Assy, MAIN [US]	A-50
	*5760110410	PCB Assy, MAIN [C]	A-50
	*5760110420	PCB Assy, MAIN [All except US, C]	A-50
6 - 4	*5760092600	Frame, Side	
6 - 5	*5760108800	Bracket, Heatsink; R	
6 - 6	*5760109700	PCB Assy, PUSH SW-A [All except C]	A-70
	*5760109710	PCB Assy, PUSH SW-A [C]	A-70
	*5760110600	PCB Assy, PUSH SW-A [All except C]	A-50
	*5760110610	PCB Assy, PUSH SW-A [C]	A-50
6 - 7	*5760109800	PCB Assy, PUSH SW-B·C [All except C]	
	*5760109810	PCB Assy, PUSH SW-B·C [C]	
6 - 8	*5760121500	Heatsink, B	A-70
	*5760121400	Heatsink, A	A-50
6 - 9	*5760108700	Bracket, Heatsink; L	
6 - 10	△*5332011200	Socket, Voltage Selector [GE]	
6 - 11	△*5133014000	Plug, Voltage Selector [GE]	
6 - 12	*5760108500	Bracket, VR	
6 - 13	*5760109300	PCB Assy, SELECTOR SW [All except C]	
	*5760109310	PCB Assy, SELECTOR SW [C]	
6 - 14	*5760109500	PCB Assy, HEADPHON JACK [All except C]	
	*5760109510	PCB Assy, HEADPHON JACK [C]	
6 - 15	5760093900	Rod, Power Switch	
6 - 16	△ 5760117900	Switch, Power [US, C]	
	△*5760118000	Switch, Power [All except US, C]	
6 - 17	△*5760099900	Spark Killer [US, C]	
	△*5267703100	Spark Killer [All except US, C]	
6 - 18	△*5760117000	Transformer, Power [US, C]	A-70
	△*5760117100	Transformer, Power [GE]	A-70
	△*5760117200	Transformer, Power [E]	A-70
	△*5760117300	Transformer, Power [UK, A]	A-70
	△*5760117500	Transformer, Power [US, C]	A-50
	△*5760117600	Transformer, Power [GE]	A-50
	△*5760117700	Transformer, Power [E]	A-50
	△*5760117800	Transformer, Power [UK, A]	A-50
6 - 19	*5760108200	Bracket, Transformer	

[US]: U.S.A. [C]: CANADA [GE]: GENERAL EXPORT [E]: EUROPE [UK]: U.K. [A]: AUSTRALIA

## ASSEMBLING HARDWARE CODING LIST

All screws conform to ISO standards, and have crossrecessed heads, unless otherwise noted. ISO screws have the head inscribed with a point as in the figure to the right.

FOR EXAMPLE:

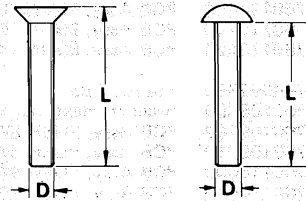
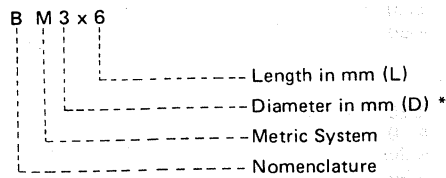

\* Inner dia. for washers and nuts

	Code	Name	Type		Code	Name	Type
MACHINE SCREW	<b>R</b>	Round Head Screw		TAPPING SCREW	<b>BTA</b>	Binding Head Tapping Screw(A Type)	
	<b>P</b>	Pan Head Screw			<b>BTB</b>	Binding Head Tapping Screw(B Type)	
	<b>T</b>	Stove Head Screw (Truss)			<b>RTA</b>	Round Head Tapping Screw(A Type)	
	<b>B</b>	Binding Head Screw			<b>RTB</b>	Round Head Tapping Screw(B Type)	
	<b>F</b>	Flat Countersunk Head Screw		SETSCREW	<b>SF</b>	Hex Socket Setscrew(Flat Point)	
	<b>O</b>	Oval Countersunk Head Screw			<b>SC</b>	Hex Socket Setscrew(Cup Point)	
WOOD SCREW	<b>RW</b>	Round Head Wood Screw		<b>SS</b>	Slotted Socket Setscrew(Flat Point)		
TAPTITE SCREW	<b>PTT</b>	Pan Head Taptite Screw		WASHER	<b>E</b>	E-Ring (Retaining Washer)	
	<b>WTT</b>	Washer Head Taptite Screw			<b>W</b>	Flat Washer (Plain)	
SEMS SCREW	<b>BSA</b>	Binding Head SEMS Screw(A Type)			<b>SW</b>	Lock Washer (Spring)	
	<b>BSB</b>	Binding Head SEMS Screw(B Type)			<b>LWI</b>	Lock Washer (Internal Teeth)	
	<b>BSF</b>	Binding Head SEMS Screw(F Type)			<b>LWE</b>	Lock Washer (External Teeth)	
	<b>PSA</b>	Pan Head SEMS Screw(A Type)		<b>TW</b>	Trim Washer (Countersunk)		
	<b>PSB</b>	Pan Head SEMS Screw(B Type)		NUT	<b>N</b>	Hex Nut	

# 7 PC BOARDS AND PARTS LIST

PC Boards shown viewed from foil side.

## MAIN PCB ASSY (A-70)

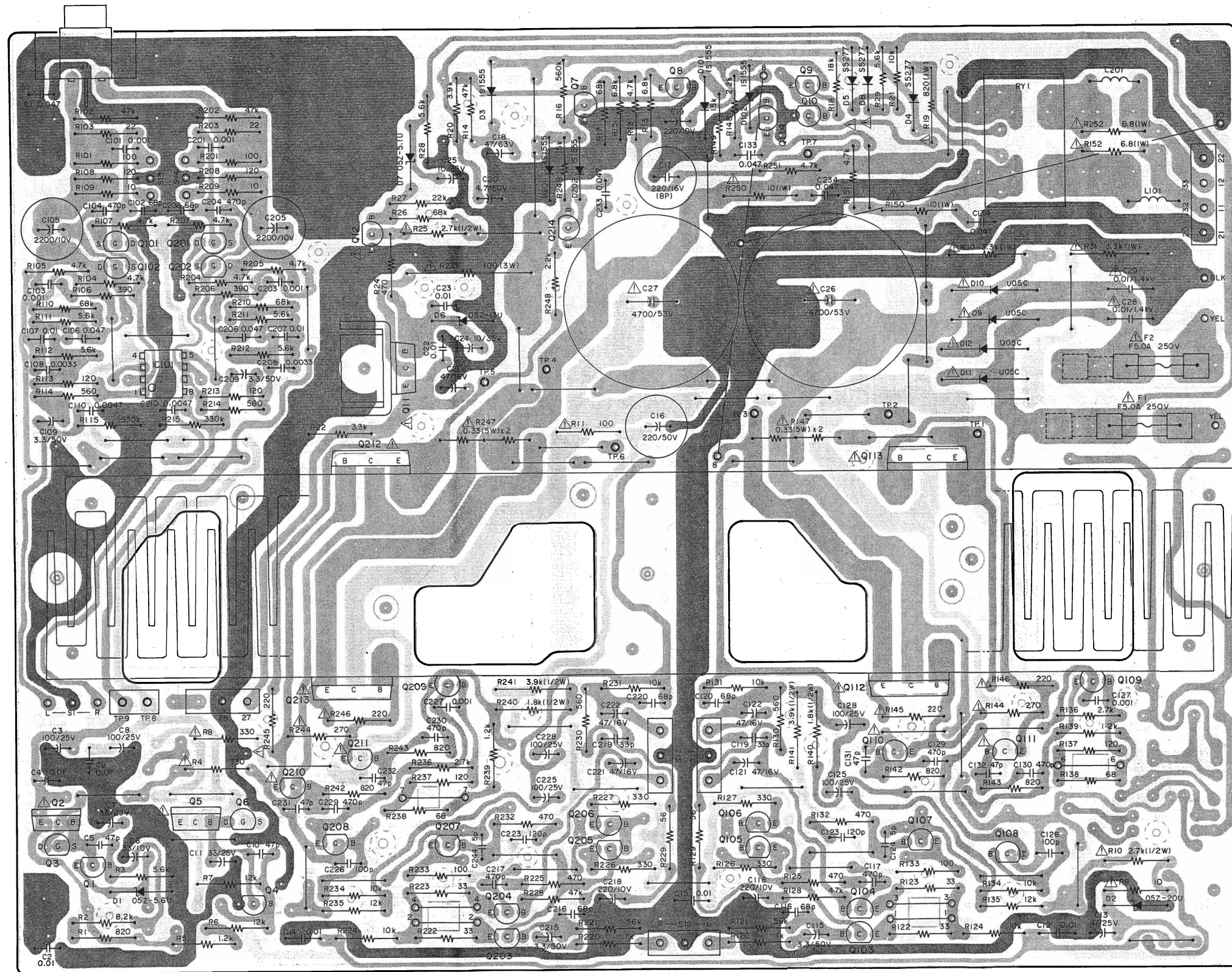

A-70/A-50

A-70/A-50

MAIN PCB ASSY (A-50)

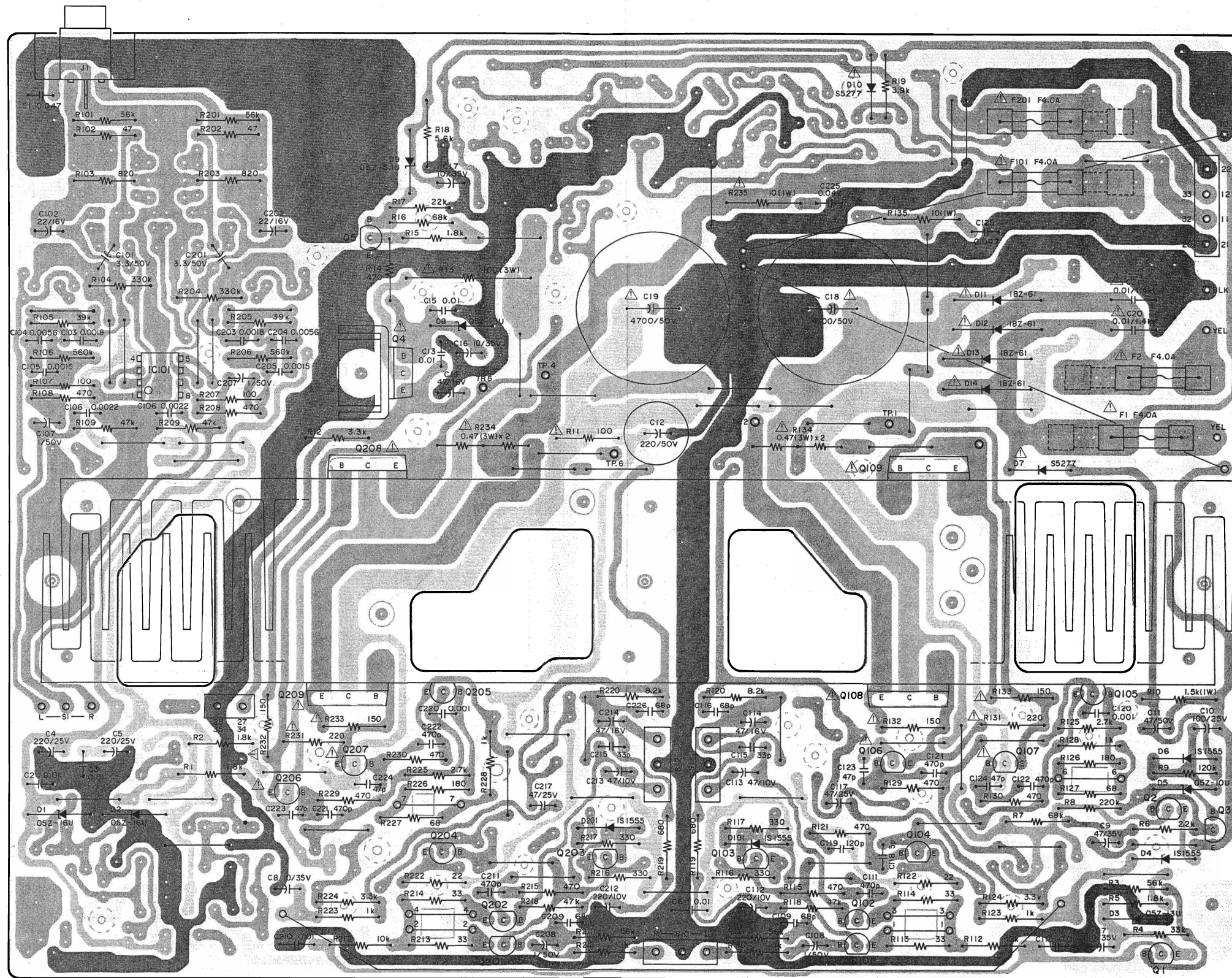

## SELECTOR SW PCB ASSY (A-70/A-50)

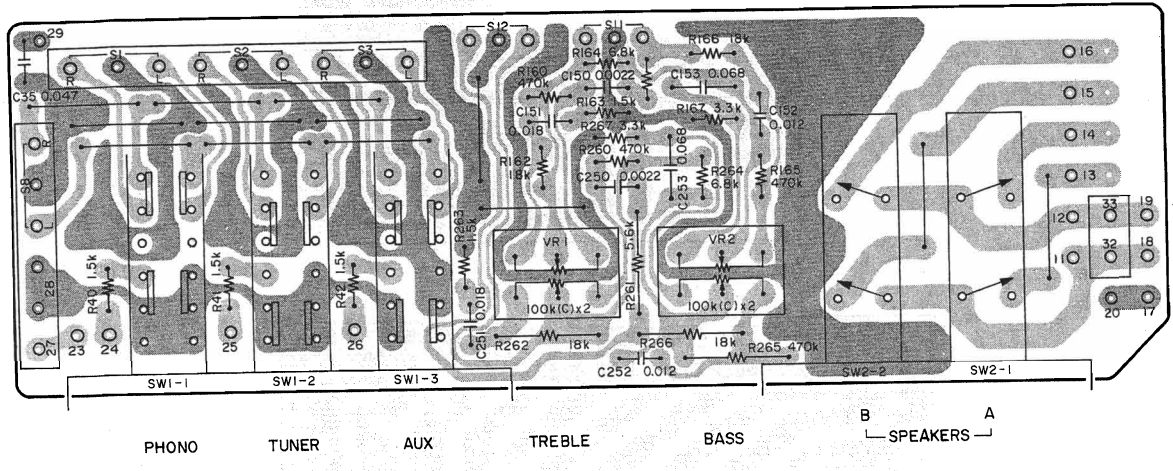

## PUSH SW PCB A ASSY (A-70/A-50)

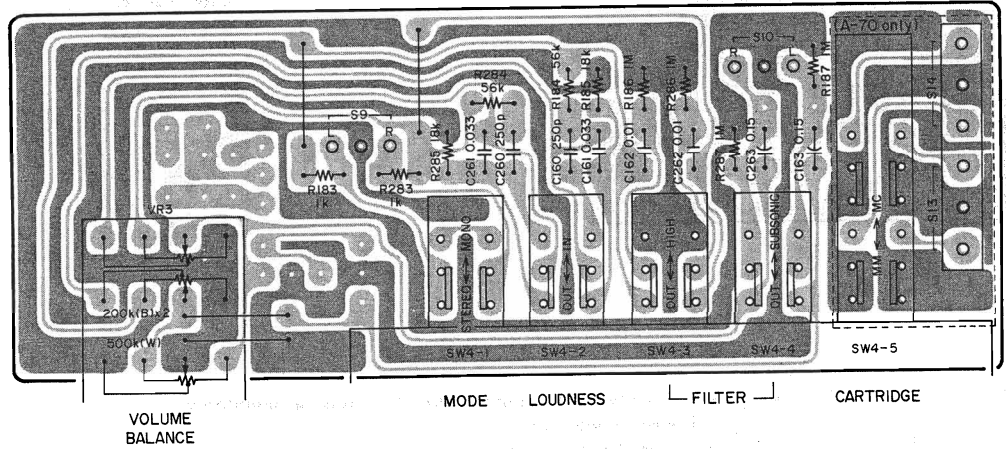





## MAIN PCB ASSY (A-70)

REF. NO.	PARTS NO.	DESCRIPTION
	5760109200	PCB Assy [US]
	5760109210	PCB Assy [C]
	5760109220	PCB Assy [GE, E, UK, A]
	5760111700	PCB [All except C]
	5760118100	PCB [C]
<b>IC</b>		
IC101	5147064000	NJM4559DD
<b>TRANSISTORS</b>		
Q1	5230770300	2SC1815Y or GR
Q2	△5231755100	2SD880Y
Q3	5232005100	FET 2SK246Y
Q4	5145150000	2SA1015Y or GR
Q5	△5760122600	2SB834Y
Q6	5232005100	FET 2SK246Y
Q7~Q9	5230770300	2SC1815Y or GR
Q10	5760121800	2SC1627AY
Q11	△5231755100	2SD880Y
Q12	△5230770300	2SC1815Y or GR
Q101, Q201	5760102300	FET 2SK170Y
Q102, Q202	5760102300	FET 2SK170Y
Q103, Q203	5145149000	2SA970GR or BL
Q104, Q204	5145149000	2SA970GR or BL
Q105, Q205	5230770300	2SC1815Y or GR
Q106, Q206	5230770300	2SC1815Y or GR
Q107, Q207	5145153000	2SC2240GR or BL
Q108, Q208	5145169000	2SC2235Y
Q109, Q209	5230770300	2SC1815Y or GR
Q110, Q210	△5145169000	2SC2235Y
Q111, Q211	△5145168000	2SA965Y
Q112, Q212	△5145171000	2SD7180
Q113, Q213	△5145170000	2SB6880
Q114, Q214	5230770300	2SC1815Y or GR
<b>DIODES</b>		
D1	5760140400	Zener 05Z-5.6U
D2	5760140200	Zener 05Z-20U
D3	5042220000	1S1555
D4, D5	△5224012600	S5277
D6	5760140300	Zener 05Z-13U
D7	5760140500	Zener 05Z-5.1U
D8	△5224012600	S5227
D9~D12	△5143017000	U05C
D101, D201	5042220000	1S1555
D102, D202	5042220000	1S1555
<b>RESISTORS</b>		
All resistors are rated ±5% tolerance, ¼ watt and are carbon type unless otherwise noted.		
R1	5181280000	820Ω
R2	5181304000	8.2kΩ
R3	5181300000	5.6kΩ
R4	△5184261000	330Ω Nonflammable
R5	5181284000	1.2kΩ
R6, R7	5181308000	12kΩ
R8	△5184261000	330Ω Nonflammable
R9	△5181234000	10Ω
R10	△5180092000	2.7kΩ ½W
R11	△5184249000	100Ω Nonflammable

REF. NO.	PARTS NO.	DESCRIPTION
R12	5181298000	4.7kΩ
R13	5181302000	6.8kΩ
R14	5181322000	47kΩ
R15	5181302000	6.8kΩ
R16	5181348000	560kΩ
R17	5181326000	68kΩ
R18	5181312000	18kΩ
R19	△5760141000	820Ω 1W Metal Film
R20	5181296000	3.9kΩ
R21	5181306000	10kΩ
R22	5181294000	3.3kΩ
R23	△5760120700	100Ω 3W Cement
R24	5181274000	470Ω
R25	△5180092000	2.7kΩ ½W
R26	5181326000	68kΩ
R27	5181314000	22kΩ
R28, R29	5181300000	5.6kΩ
R30, R31	△5760141100	3.3kΩ 1W Metal Film
R101, R201	5181258000	100Ω
R102, R202	5181322000	47kΩ
R103, R203	5181242000	22Ω
R104, R204	5181298000	4.7kΩ
R105, R205	5181298000	4.7kΩ
R106, R206	5181272000	390Ω
R107, R207	5181298000	4.7kΩ
R108, R208	5181260000	120Ω
R109, R209	5181234000	10Ω
R110, R210	5181326000	68kΩ
R111, R211	5181300000	5.6kΩ
R112, R212	5181300000	5.6kΩ
R113, R213	5181260000	120Ω
R114, R214	5181276000	560Ω
R115, R215	5181342000	330kΩ
R120, R220	5181282000	1kΩ
R121, R221	5181324000	56kΩ
R122, R222	5181246000	33Ω
R123, R223	5181246000	33Ω
R124, R224	5181306000	10kΩ
R125, R225	5181274000	470Ω
R126, R226	5181270000	330Ω
R127, R227	5181270000	330Ω
R128, R228	5181322000	47kΩ
R129, R229	5181252000	56Ω
R130, R230	5181276000	560Ω
R131, R231	5181306000	10kΩ
R132, R232	5181274000	470Ω
R133, R233	5181258000	100Ω
R134, R234	5181306000	10kΩ
R135, R235	5181308000	12kΩ
R136, R236	5181292000	2.7kΩ
R137, R237	5181260000	120Ω
R138, R238	5181254000	68Ω
R139, R239	5181284000	1.2kΩ
R140, R240	5180088000	1.8kΩ ½W
R141, R241	5180096000	3.9kΩ ½W
R142, R242	5181280000	820Ω
R143, R243	5181280000	820Ω
R144, R244	△5184259000	270Ω Nonflammable
R145, R245	△5184257000	220Ω Nonflammable
R146, R246	△5184257000	220Ω Nonflammable

REF. NO.	PARTS NO.	DESCRIPTION			
R147, R247	△ 5760120600	0.33Ωx2	5W	Cement	
R148, R248	5181290000	2.2kΩ			
R149, R249	5181310000	15kΩ			
R150, R250	△ 5760140900	10Ω	1W	Metal Film	
R151, R251	5181298000	4.7kΩ			
R152, R252	△ 5760140800	6.8Ω	1W	Metal Film	
<b>CAPACITORS</b>					
C1	5173395000	Ceramic	0.047μF	50V	
C2	5173393000	Ceramic	0.01μF	50V	
C3	5172935000	Elec.	100μF	25V	
C4	5173393000	Ceramic	0.01μF	50V	
C5	5172308000	Ceramic	47pF	50V	
C6	5172915000	Elec.	33μF	10V	
C7	5172917000	Elec.	33μF	25V	
C8	5172935000	Elec.	100μF	25V	
C9	5173393000	Ceramic	0.01μF	50V	
C10	5172308000	Ceramic	47pF	50V	
C11	5172917000	Elec.	33μF	25V	
C12	5173393000	Ceramic	0.01μF	50V	
C13	5172926000	Elec.	47μF	25V	
C14, C15	5173393000	Ceramic	0.01μF	50V	
C16	5172946000	Elec.	220μ	50V	
C17	5260071400	Elec.	22μF	16V (BP)	
C18	5172929000	Elec.	47μF	63V	
C19	5172942000	Elec.	220μF	10V	
C20	5173006000	Elec.	4.7μF	50V	
C21	5172925000	Elec.	47μF	16V	
C22, C23	5173393000	Ceramic	0.01μF	50V	
C24, C25	5172902000	Elec.	10μF	35V	
C26, C27	△ 5760103600	Elec.	4700μF	53V	
C28, C29	△ 5760141200	Ceramic	0.01μF	1.4kV	
C101, C201	5173390000	Ceramic	0.001μF	50V	
C102, C202	5172310000	Ceramic	68pF	50V	
C103, C203	5173390000	Ceramic	0.001μF	50V	
C104, C204	5172320000	Ceramic	470pF	50V	
C105, C205	5172976000	Elec.	2200μF	10V	
C106, C206	5054738800	Mylar	0.047μF	50V	5%
C107, C207	5054877800	Mylar	0.01μF	50V	5%
C108, C208	5054881800	Mylar	0.0033μF	50V	5%
C109, C209	5172890000	Elec.	3.3μF	50V	
C110, C210	5054813000	Mylar	0.0047μF	50V	
C115, C215	5172890000	Elec.	3.3μF	50V	
C116, C216	5172310000	Ceramic	68pF	50V	
C117, C217	5172320000	Ceramic	470pF	50V	
C118, C218	5172942000	Elec.	220μF	10V	
C119, C219	5172306000	Ceramic	33pF	50V	
C120, C220	5172310000	Ceramic	68pF	50V	
C121, C221	5172925000	Elec.	47μF	16V	
C122, C222	5172925000	Elec.	47μF	16V	
C123, C223	5172313000	Ceramic	120pF	50V	
C124, C224	5173400000	Ceramic	5pF	50V	
C125, C225	5172935000	Elec.	100μF	25V	
C126, C226	5172312000	Ceramic	100pF	50V	
C127, C227	5173390000	Ceramic	0.001μF	50V	
C128, C228	5172935000	Elec.	100μF	25V	
C129, C229	5172320000	Ceramic	470pF	50V	
C130, C230	5172320000	Ceramic	470pF	50V	
C131, C231	5172308000	Ceramic	47pF	50V	
C132, C232	5172308000	Ceramic	47pF	50V	

REF. NO.	PARTS NO.	DESCRIPTION			
C133, C233	5054827000	Mylar	0.047μF	50V	
C134, C234	5054827000	Mylar	0.047μF	50V	
<b>COILS</b>					
L101, L201	5760120900		2.2μH		
<b>FUSES</b>					
F1, F2	△ 5760080700	125V	F5A [US, C]		
	△ 5142174000	250V	F5A [GE, E, UK, A]		
<b>MISCELLANEOUS</b>					
J1	5760142100	Pin Jack, 2P			
	5760102200	Heatsink			
	5142087000	Holder, Fuse (4 used)			
	5760121000	Relay			
	5760115500	Pin, Lapping (10 used)			
	5760115600	Pin, Lapping; 2P (2 used)			
	5760115700	Pin, Lapping; 3P (3 used)			
	5760115800	Pin, Lapping; 4P			

### MAIN PCB ASSY (A-50)

REF. NO.	PARTS NO.	DESCRIPTION			
	5760110400	PCB Assy [US]			
	5760110410	PCB Assy [C]			
	5760110420	PCB Assy [GE, E, UK, A]			
	5760111700	PCB [All except C]			
	5760118100	PCB [C]			
<b>IC</b>					
IC101	5147064000	NJM4559DD			
<b>TRANSISTORS</b>					
Q1	5145150000	2SA1015Y			
Q2	5760121800	2SC1627AY			
Q3	5230770300	2SC1815Y			
Q4	△ 5231755100	2SD880Y			
Q5	5230770300	2SC1815Y			
Q101, Q201	5145149000	2SA970GR			
Q102, Q202	5145149000	2SA970GR			
Q103, Q203	5230770300	2SC1815Y			
Q104, Q204	5145167000	2SC2229Y			
Q105, Q205	5230770300	2SC1815Y			
Q106, Q206	△ 5760121800	2SC1627AY			
Q107, Q207	△ 5760121900	2SA817AY			
Q108, Q208	△ 5145165000	2SD7160			
Q109, Q209	△ 5145172000	2SB6860			
<b>DIODES</b>					
D1, D2	5760140600	Zener 05Z-16U			
D3	5760140300	Zener 05Z-13U			
D4	5042220000	1S1555			
D5	5760140700	Zener 05Z-10U			
D6	5042220000	1S1555			
D7	△ 5760121700	S5277			
D8	5760140300	Zener 05Z-13U			
D9	5760140500	Zener 05Z-5.1U			
D10	△ 5760121700	S5277			
D11~D14	△ 5760121600	1BZ-61			

[US]: U.S.A. [C]: CANADA [GE]: GENERAL EXPORT [E]: EUROPE [UK]: U.K. [A]: AUSTRALIA

REF. NO.	PARTS NO.	DESCRIPTION
D101, D201	5042220000	1S1555
<b>RESISTORS</b>		
All resistors are rated $\pm 5\%$ tolerance, $\frac{1}{4}$ watt and are carbon type unless otherwise noted.		
R1, R2	5181288000	1.8k $\Omega$
R3	5181324000	56k $\Omega$
R4	5181318000	33k $\Omega$
R5	5181288000	1.8k $\Omega$
R6	5181290000	2.2k $\Omega$
R7	5181326000	68k $\Omega$
R8	5181338000	220k $\Omega$
R9	5181332000	120k $\Omega$
R10	5760141500	1.5k $\Omega$ 1W Metal Film
R11	$\Delta$ 5184249000	100 $\Omega$ Nonflammable
R12	5181294000	3.3k $\Omega$
R13	$\Delta$ 5760141600	100 $\Omega$ 3W Cement
R14	5181274000	470 $\Omega$
R15	5181288000	1.8k $\Omega$
R16	5181326000	68k $\Omega$
R17	5181314000	22k $\Omega$
R18	5181300000	5.6k $\Omega$
R19	5181296000	3.9k $\Omega$
R101, R201	5181324000	56k $\Omega$
R102, R202	5181250000	47 $\Omega$
R103, R203	5181280000	820 $\Omega$
R104, R204	5181342000	330k $\Omega$
R105, R205	5181320000	39k $\Omega$
R106, R206	5181348000	560k $\Omega$
R107, R207	5181258000	100 $\Omega$
R108, R208	5181274000	470 $\Omega$
R109, R209	5181322000	47k $\Omega$
R110, R210	5181282000	1k $\Omega$
R111, R211	5181324000	56k $\Omega$
R112, R212	5181306000	10k $\Omega$
R113, R213	5181246000	33 $\Omega$
R114, R214	5181246000	33 $\Omega$
R115, R215	5181274000	470 $\Omega$
R116, R216	5181270000	330 $\Omega$
R117, R217	5181270000	330 $\Omega$
R118, R218	5181322000	47k $\Omega$
R119, R219	5181278000	680 $\Omega$
R120, R220	5181304000	8.2k $\Omega$
R121, R221	5181274000	470 $\Omega$
R122, R222	5181242000	22 $\Omega$
R123, R223	5181282000	1k $\Omega$
R124, R224	5181294000	3.3k $\Omega$
R125, R225	5181292000	2.7k $\Omega$
R126, R226	5181264000	180 $\Omega$
R127, R227	5181254000	68 $\Omega$
R128, R228	5181282000	1k $\Omega$
R129, R229	$\Delta$ 5184265000	470 $\Omega$ Nonflammable
R130, R230	$\Delta$ 5184265000	470 $\Omega$ Nonflammable
R131, R231	$\Delta$ 5184257000	220 $\Omega$ Nonflammable
R132, R232	$\Delta$ 5184253000	150 $\Omega$ Nonflammable
R133, R233	$\Delta$ 5184253000	150 $\Omega$ Nonflammable
R134, R234	$\Delta$ 5760141700	0.47 $\Omega$ x2 3W Cement
R135, R235	$\Delta$ 5760140900	10 $\Omega$ 1W Metal Film

REF. NO.	PARTS NO.	DESCRIPTION
<b>CAPACITORS</b>		
C1	5173395000	Ceramic 0.047 $\mu$ F 50V
C2, C3	5173393000	Ceramic 0.01 $\mu$ F 50V
C4, C5	5172944000	Elec. 220 $\mu$ F 25V
C6	5173393000	Ceramic 0.01 $\mu$ F 50V
C7, C8	5172902000	Elec. 10 $\mu$ F 35V
C9	5172927000	Elec. 47 $\mu$ F 35V
C10	5172935000	Elec. 100 $\mu$ F 25V
C11	5172928000	Elec. 47 $\mu$ F 50V
C12	5172946000	Elec. 220 $\mu$ F 50V
C13	5173393000	Ceramic 0.01 $\mu$ F 50V
C14	5172925000	Elec. 47 $\mu$ F 16V
C15	5173393000	Ceramic 0.01 $\mu$ F 50V
C16, C17	5172902000	Elec. 10 $\mu$ F 35V
C18, C19	$\Delta$ 5760128800	Elec. 3300 $\mu$ F 50V
C20, C21	$\Delta$ 5760141200	Ceramic 0.01 $\mu$ F 1.4kV
C101, C201	5172890000	Elec. 3.3 $\mu$ F 50V
C102, C202	5172908000	Elec. 22 $\mu$ F 16V
C103, C203	5054888800	Mylar 0.0018 $\mu$ F 50V 5%
C104, C204	5054892800	Mylar 0.0056 $\mu$ F 50V 5%
C105, C205	5054896800	Mylar 0.0015 $\mu$ F 50V 5%
C106, C206	5054876800	Mylar 0.0022 $\mu$ F 50V 5%
C107, C207	5172882000	Elec. 1 $\mu$ F 50V
C108, C208	5172882000	Elec. 1 $\mu$ F 50V
C109, C209	5172310000	Ceramic 68pF 50V
C110, C210	5173393000	Ceramic 0.01 $\mu$ F 50V
C111, C211	5172320000	Ceramic 470pF 50V
C112, C212	5172907000	Elec. 220 $\mu$ F 10V
C113, C213	5172924000	Elec. 47 $\mu$ F 10V
C114, C214	5172924000	Elec. 47 $\mu$ F 10V
C115, C215	5172306000	Ceramic 33pF 50V
C116, C216	5172306000	Ceramic 33pF 50V
C117, C217	5172926000	Elec. 47 $\mu$ F 25V
C118, C218	5173400000	Ceramic 5pF 50V
C119, C219	5172313000	Ceramic 120pF 50V
C120, C220	5173390000	Ceramic 0.001 $\mu$ F 50V
C121, C221	5172320000	Ceramic 470pF 50V
C122, C222	5172320000	Ceramic 470pF 50V
C123, C223	5172308000	Ceramic 47pF 50V
C124, C224	5172308000	Ceramic 47pF 50V
C125, C225	5054827000	Mylar 0.047 $\mu$ F 50V
<b>FUSES</b>		
F1, F2	$\Delta$ 5760100400	125V F4A [US, C]
	$\Delta$ 5041156000	250V F4A [GE, E, UK, A]
F101, F201	$\Delta$ 5760100400	125V F4A [US, C]
	$\Delta$ 5041156000	250V F4A [GE, E, UK, A]
<b>MISCELLANEOUS</b>		
J1	5760142100	Pin Jack, 2P
	5760102200	Heatsink
	5142087000	Holder, Fuse (8 used)
	5760115500	Pin, Lapping (9 used)
	5760115600	Pin, Lapping; 2P
	5760115700	Pin, Lapping; 3P (3 used)
	5760115800	Pin, Lapping; 4P

# A-70/A-50

## SELECTOR SW PCB ASSY (A-70/A-50)

REF. NO.	PARTS NO.	DESCRIPTION
	5760109300	PCB Assy [All except C]
	5760109310	PCB Assy [C]
	5760110900	PCB [All except C]
	5760110500	PCB [C]
<b>CARBON RESISTORS</b>		
All resistors are rated $\pm 5\%$ tolerance and $\frac{1}{4}$ watt.		
R40~R42	5240168600	1.5k $\Omega$
R160, R260	5240174600	470k $\Omega$
R161	5240170000	5.6k $\Omega$
R261	5181300000	5.6k $\Omega$
R162	5240171200	18k $\Omega$
R262	5181312000	18k $\Omega$
R163, R263	5240168600	1.5k $\Omega$
R164, R264	5240170200	6.8k $\Omega$
R165	5240174600	470k $\Omega$
R265	5181346000	470k $\Omega$
R166	5240171200	18k $\Omega$
R266	5181312000	18k $\Omega$
R167, R267	5240169400	3.3k $\Omega$
<b>CAPACITORS</b>		
C35	5173395000	Ceramic 0.047 $\mu$ F 50V
C150, C250	5054845000	Mylar 0.0022 $\mu$ F 50V
C151, C251	5054855000	Mylar 0.018 $\mu$ F 50V
C152, C252	5054862000	Mylar 0.012 $\mu$ F 50V
C153, C253	5054854000	Mylar 0.068 $\mu$ F 50V
<b>VARIABLE RESISTORS</b>		
VR1, VR2	5760121100	100k $\Omega$ (C)x2
<b>MISCELLANEOUS</b>		
SW1	5760118300	Push Switch, 3-gang
SW2	5760118400	Push Switch, 2-gang
	5760115600	Pin, Lapping; 2P
	5760115900	Pin, Lapping; 6P
	6760116000	Pin, Lapping; 9P

## PUSH SW PCB A ASSY (A-70)

REF. NO.	PARTS NO.	DESCRIPTION
	5760109700	PCB A Assy [All except C]
	5760109710	PCB A Assy [C]
	5760111300	PCB A [All except C]
	5760118700	PCB A [C]
<b>CARBON RESISTORS</b>		
All resistors are rated $\pm 5\%$ tolerance and $\frac{1}{4}$ watt.		
R183, R283	5240168200	1k $\Omega$
R184, R284	5240172400	56k $\Omega$
R185, R285	5240171200	18k $\Omega$
R186, R286	5240175400	1M $\Omega$
R187, R287	5240175400	1M $\Omega$
<b>CAPACITORS</b>		
C160, C260	5172318000	Ceramic 250pF 50V
C161, C261	5054824000	Mylar 0.033 $\mu$ F 50V
C162, C262	5054802000	Mylar 0.01 $\mu$ F 50V
C163, C263	5054665000	Tant. 0.15 $\mu$ F 35V
<b>VARIABLE RESISTOR</b>		
VR3	5760121200	250k $\Omega$ (B)x2, 500k $\Omega$ (W)
<b>MISCELLANEOUS</b>		
SW4	5760119000	Push Switch, 5-gang
	5760115900	Pin, Lapping; 6P

## PUSH SW PCB A ASSY (A-50)

REF. NO.	PARTS NO.	DESCRIPTION
	5760110600	PCB A Assy [All except C]
	5760110610	PCB A Assy [C]
	5760111300	PCB A [All except C]
	5760118700	PCB A [C]
<b>CARBON RESISTORS</b>		
All resistors are rated $\pm 5\%$ tolerance and $\frac{1}{4}$ watt.		
R183, R283	5240168200	1k $\Omega$
R184, R284	5240172400	56k $\Omega$
R185, R285	5240171200	18k $\Omega$
R186, R286	5240175400	1M $\Omega$
R187, R287	5240175400	1M $\Omega$
<b>CAPACITORS</b>		
C160, C260	5172317000	Ceramic 250pF 50V
C161, C261	5054824000	Mylar 0.033 $\mu$ F 50V
C162, C262	5054802000	Mylar 0.01 $\mu$ F 50V
C163, C263	5054665000	Tant. 0.15 $\mu$ F 35V
<b>VARIABLE RESISTOR</b>		
VR3	5760121200	250k $\Omega$ (B)x2, 500k $\Omega$ (W)
<b>MISCELLANEOUS</b>		
SW4	5760119100	Push Switch, 4-gang

[US]: U.S.A. [C]: CANADA [GE]: GENERAL EXPORT [E]: EUROPE [UK]: U.K. [A]: AUSTRALIA

## PUSH SW PCB BC ASSY (A-70/A-50)

REF. NO.	PARTS NO.	DESCRIPTION
	5760109800	PCB B C Assy [All except C]
	5760109810	PCB BC Assy [C]
	5760111400	PCB B [All except C]
	5760119200	PCB B [C]
	5760111500	PCB C [All except C]
	5760119300	PCB C [C]
<b>CARBON RESISTORS</b>		
C180, C280	5240172600	68k $\Omega$ 1/4W 5%
C181, C281	5240170400	8.2k $\Omega$ 1/4W 5%
C182, C282	5240168200	1k $\Omega$ 1/4W 5%
<b>CAPACITOR</b>		
C40	5173395000	Ceramic 0.047 $\mu$ F 50V
<b>MISCELLANEOUS</b>		
SW3	5760119500	Push Switch, 5-gang
	5760119400	Pin, Lapping; 15P

## DISPLAY PCB ASSY (A-70/A-50)

REF. NO.	PARTS NO.	DESCRIPTION
	5760109900	PCB Assy [All except C]
	5760109910	PCB Assy [C]
	5760111600	PCB [All except C]
	5760119600	PCB [C]
<b>IC</b>		
IC102	5760121300	LT-1048
<b>DIODES</b>		
D110, D210	5042213000	1N60
D111, D211	5042220000	1S1555
<b>CARBON RESISTORS</b>		
All resistors are rated $\pm 5\%$ tolerance and 1/4 watt.		
R50	5181316000	27k $\Omega$
R51	5181288000	1.8k $\Omega$
R190, R290	5181308000	12k $\Omega$
R191, R291	5181286000	1.5k $\Omega$
R192, R292	5181318000	33k $\Omega$
R193, R293	5181324000	56k $\Omega$
<b>CAPACITORS</b>		
C170, C270	5172896000	Elec. 4.7 $\mu$ F 50V
<b>VARIABLE RESISTOR</b>		
VR4	5280003302	Semi-fixed, 5k $\Omega$ (B)

## HEADPHONE JACK PCB ASSY (A-70/A-50)

REF. NO.	PARTS NO.	DESCRIPTION
	5760109500	PCB Assy [All except C]
	5760109510	PCB Assy [C]
	5760111100	PCB [All except C]
	5760118500	PCB [C]
<b>RESISTORS</b>		
R168, R268	5760141400	330 $\Omega$ 1W 5% Metal Film
J4	5760141300	Jack, PHONES

## SP TERMINAL PCB ASSY (A-70/A-50) (PC Board omitted)

REF. NO.	PARTS NO.	DESCRIPTION
	5760109400	PCB Assy [All except C]
	5760109410	PCB Assy [C]
	5760111000	PCB [All except C]
	5760118200	PCB [C]
J5	5760102700	Terminal, Push; 8P

## LED PCB ASSY (A-70/A-50) (PC Board omitted)

REF. NO.	PARTS NO.	DESCRIPTION
	5760109600	PCB Assy [All except C]
	5760109610	PCB Assy [C]
	5760111200	PCB [All except C]
	5760118600	PCB [C]
D20~D22	5760112400	LED PR5531K
	5760109100	Holder, LED; D

**SEMICONDUCTOR ELECTRODES**

**NJM4559DD  
(TOP VIEW)**

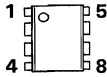

**2SB834Y**

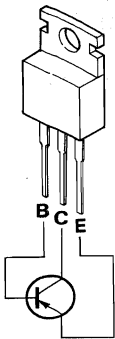

**2SD880Y**

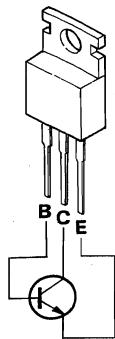

**1N60**

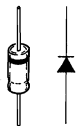

**2SA817AY  
2SA965Y**

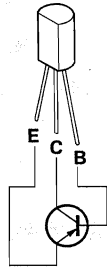

**2SC1627AY  
2SC2229Y  
2SC2235Y**

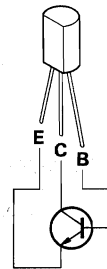

**2SK170Y  
2SK246Y**

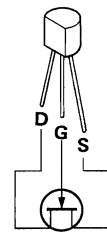

**1S1555**

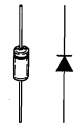

**2SA970GR  
2SA1015Y**

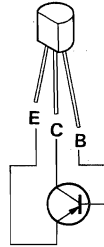

**2SC1815Y  
2SC2240GR**

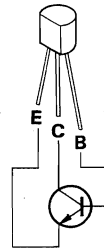

**05Z5.1U  
05Z5.6U  
05Z10U  
05Z13U  
05Z16U  
05Z20U**

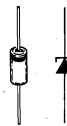

**S5277**

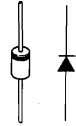

**U05C**

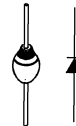

**2SB686O  
2SB688O**

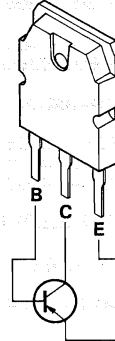

**2SD716O  
2SD718O**

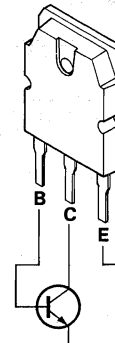

**1BZ-61**

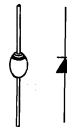

**PR5531K**

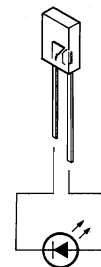

02-105A

02-105A

# TEAC SCHEMATIC DIAGRAM A-50

01

02

03

04

05

06

A

B

C

D

E

F

G

H

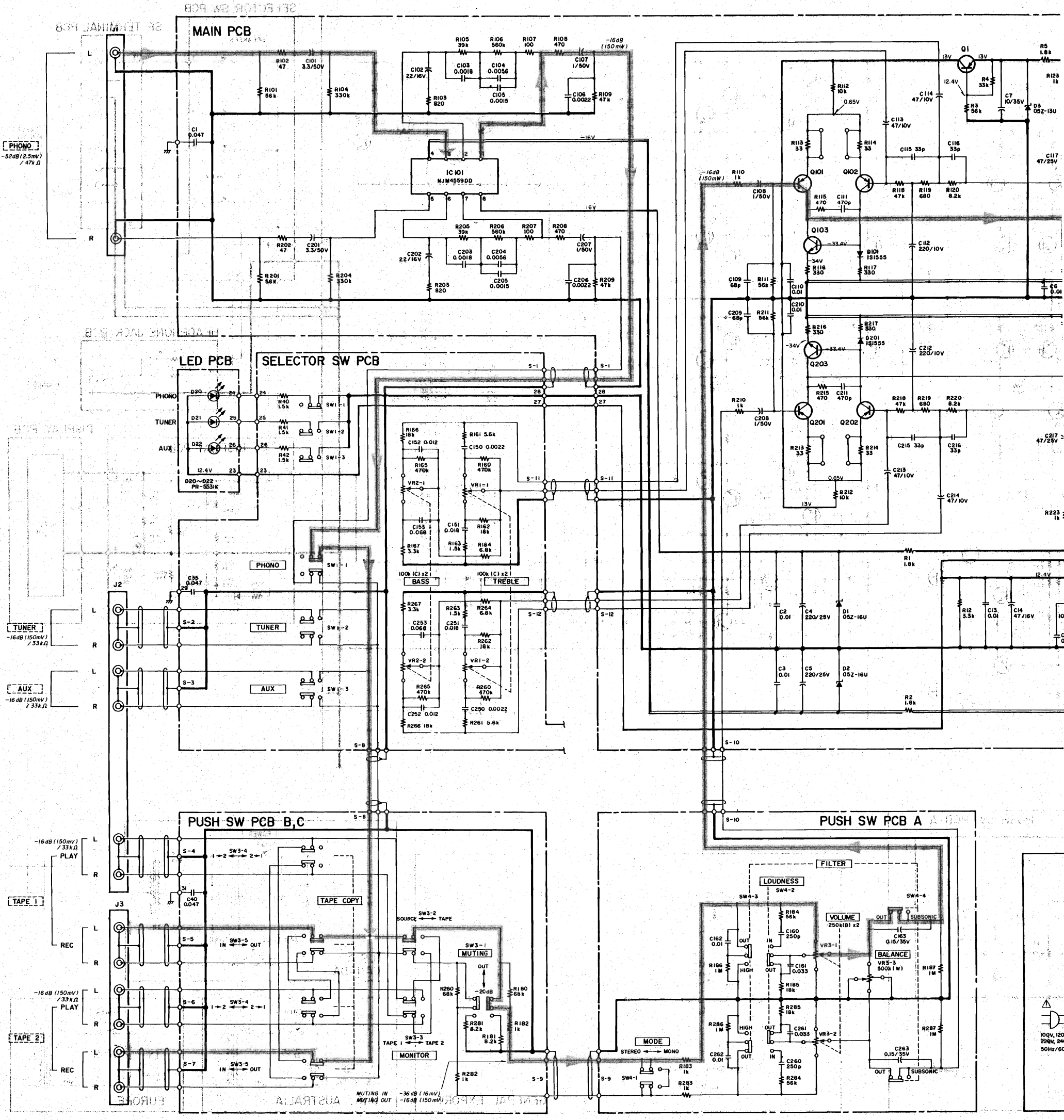

- NOTES**
- All resistors are 1/4W, ±5%, unless otherwise specified.
  - All capacitor values are in microfarads.
  - 0 dB = 1 V.
  - The DC voltages given in each portion are measured under no-signal conditions.
  - Parts marked with this sign are safety critical. They must always be replaced with identical parts. Refer to the appropriate parts list and element.
  - +B power supply
  - B power supply
  - ▶: Audio signal path (shown for L channel)
  - : Front panel indication
  - ▭: Rear panel indication

TEAC A-50 DC Integrated Stereo Amplifier



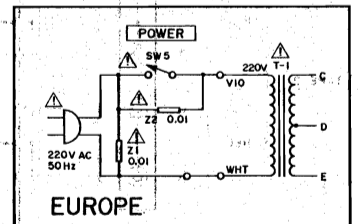
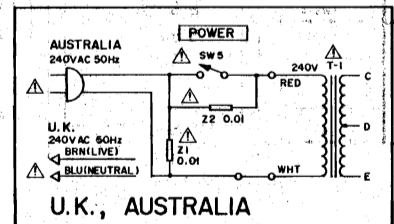
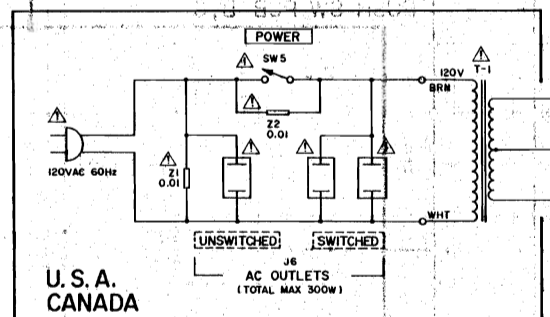
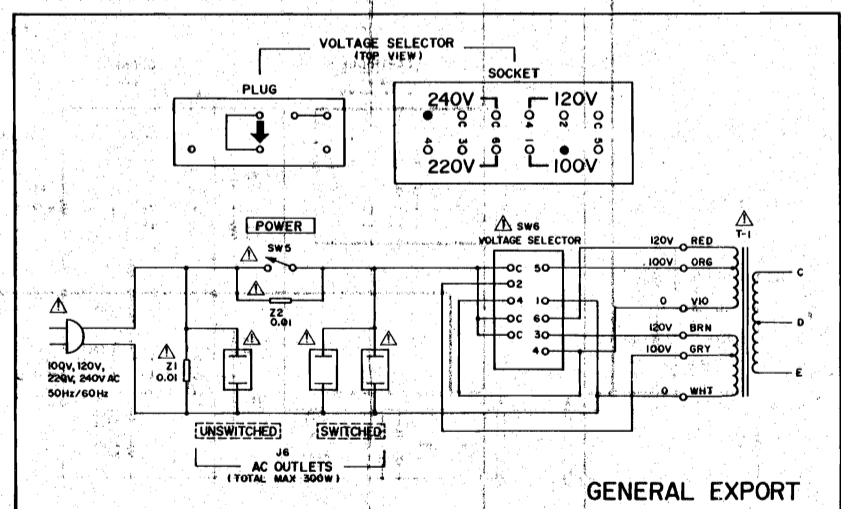
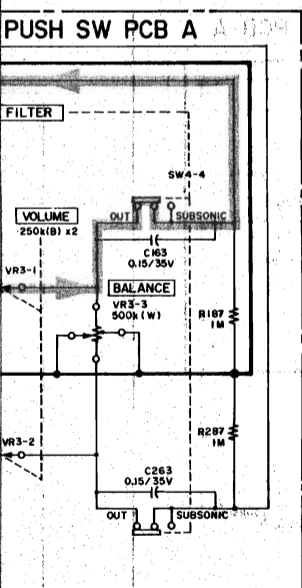
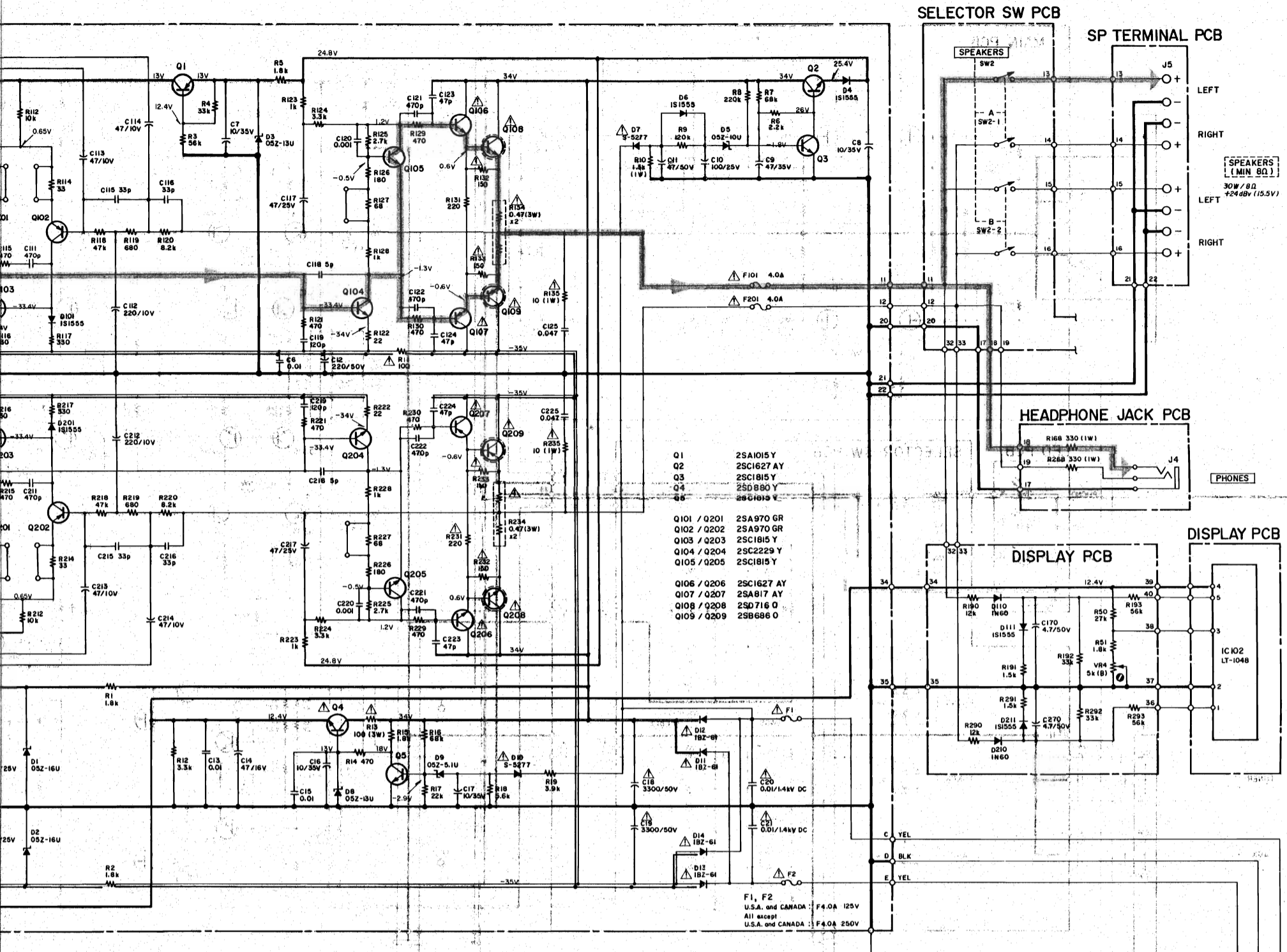

- NOTES**
- All resistors are 1/4W, ±5%, unless otherwise noted.
  - Resistor values are in ohms (k=kilo-ohms, M=mega-ohms).
  - All capacitor values are in microfarads (p=pico-farads).
  - 0 dB=1 V
  - The DC voltages given in each portion are reference values measured under no-signal conditions.
  - Parts marked with this sign are safety critical components. They must always be replaced with identical components - refer to the appropriate parts list and ensure exact replacement.
  - B power supply
  - B power supply
  - Audio signal path (shown for L ch only)
  - Front panel indication
  - Rear panel indication

# TEAC SCHEMATIC DIAGRAM A-70

01

02

03

04

05

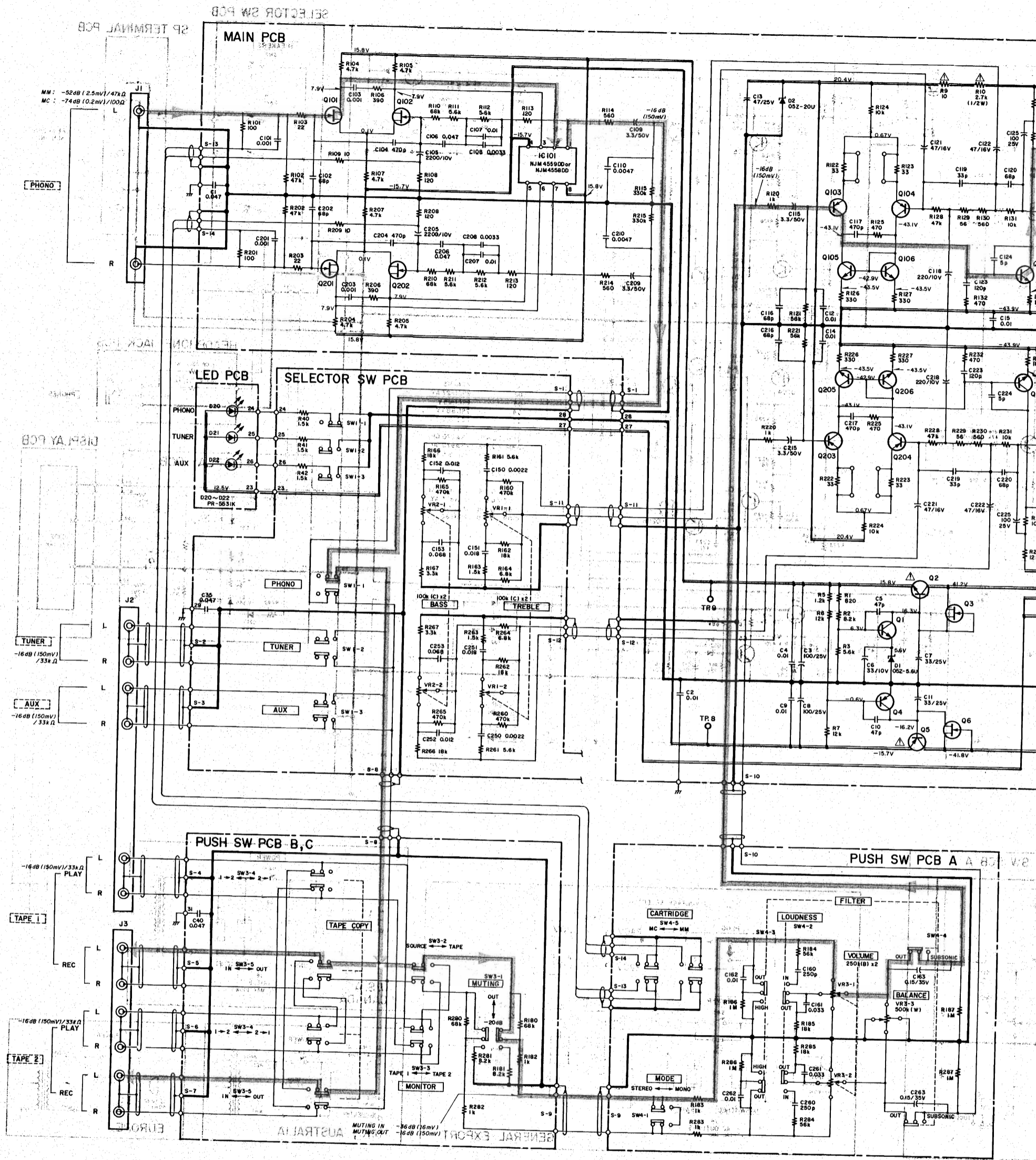

## NOTES

1. All resistors are 1/4W, ±5%, unless otherwise specified.
2. All capacitor values are in microfarads (μF) unless otherwise specified.
3. 0 dB = 1 V
4. The DC voltages given in each section are measured under no-signal conditions.
5. Parts marked with this sign must always be replaced with the same type and value. Refer to the appropriate parts list for replacement.
6. +B power supply
7. -B power supply
8. Audio signal path (shown in solid line)
9. Front panel indication
10. Rear panel indication

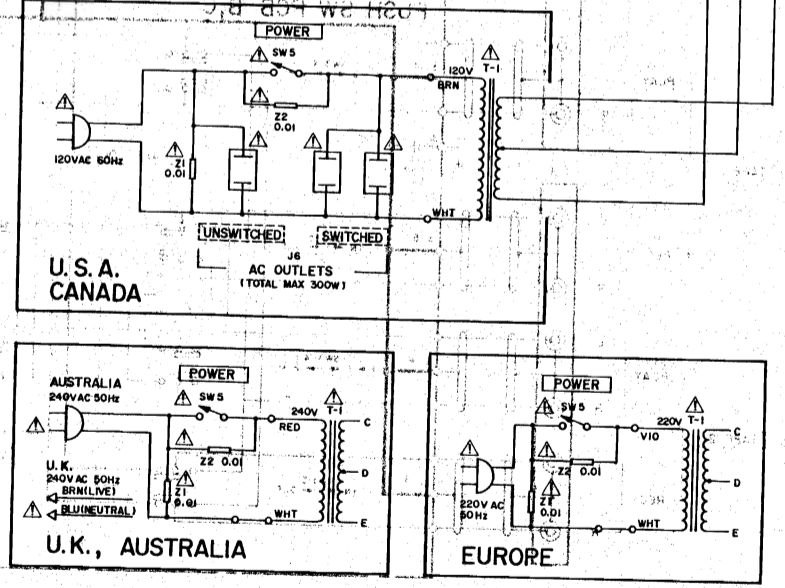
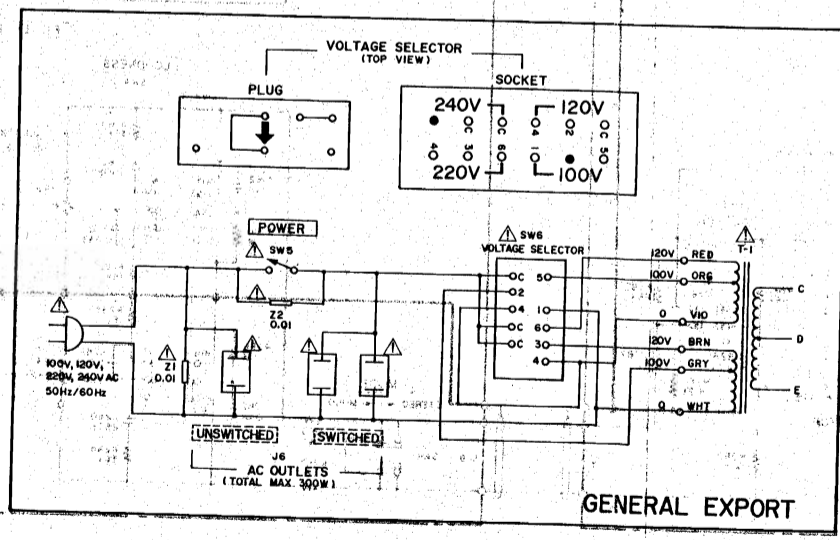
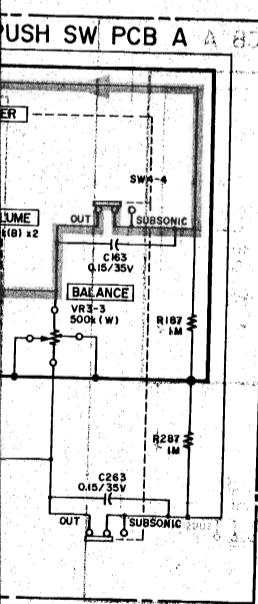
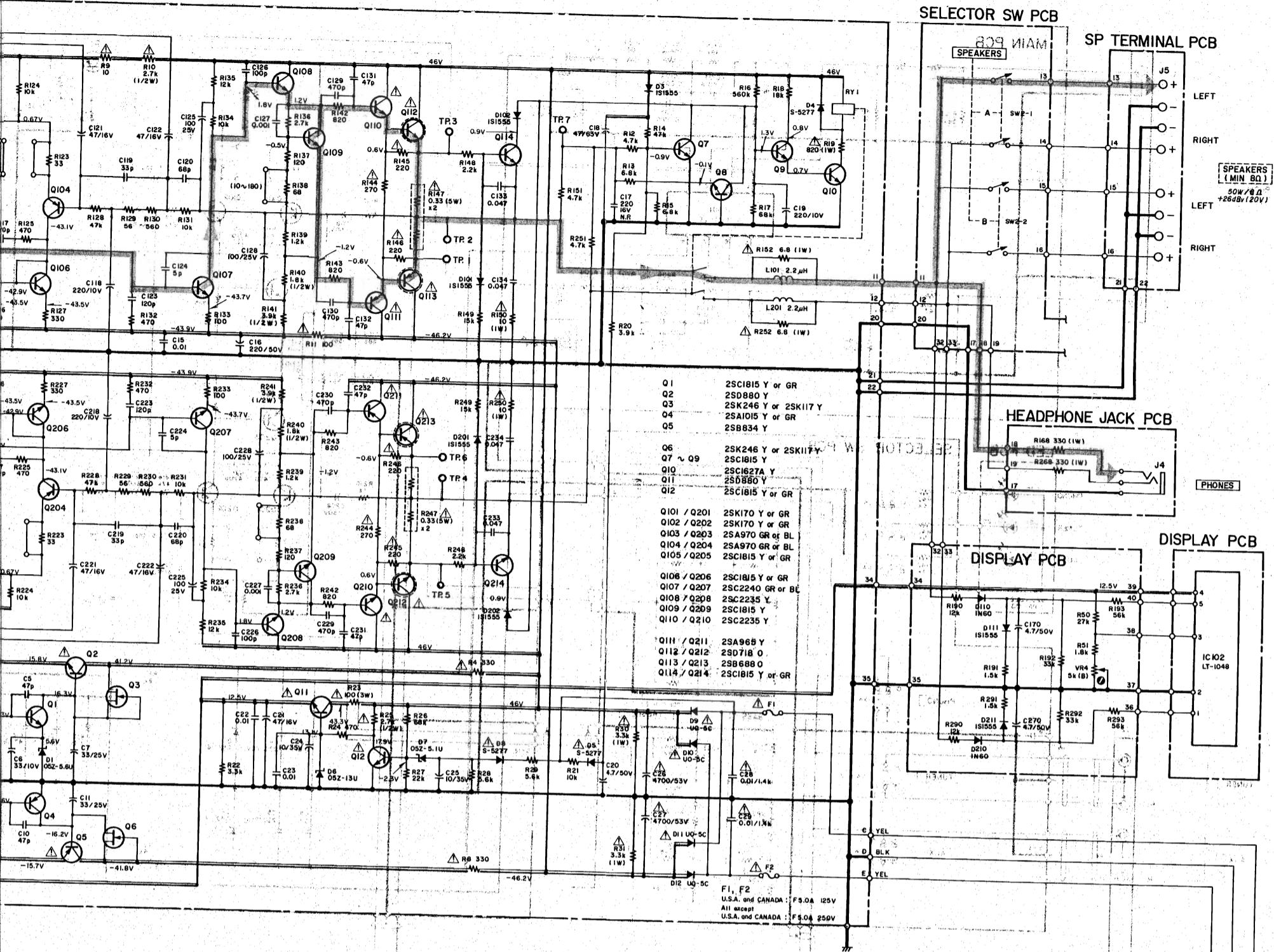

**NOTES**

All resistors are 1/4W, ±5%, unless otherwise noted.  
Resistor values are in ohms (k=kilo-ohms, M=mega-ohms).  
All capacitor values are in microfarads (p=pico-farads).  
0 dB=1 V

The DC voltages given in each portion are reference values measured under no-signal conditions.

Parts marked with this sign are safety critical components. They must always be replaced with identical components - refer to the appropriate parts list and ensure exact replacement.

⊕ +B power supply  
⊖ -B power supply  
○ Audio signal path (shown for L ch only)  
□ Front panel indication  
▭ Rear panel indication